



Giesen W6A

Features

Automatic airflow control

UL/CSA and CE certified

Automatic burner control

Every type of gas and power

Easy maintenance

Roasting and cooling at the same time

Internal cyclone

Cast iron frontplate and drum

Direct frequent drives

Made and build in The Netherlands 

Options

Data logging and profiling

Destoner

Your own choice of painting

Electrostatic filter system

GIESEN[®]
coffee-roasters



Giesen W6A

Specifications

Giesen W6A

Capacity:

500 gram - 6 kg green beans / per batch /
max. 24 kg/h

Drives:

Direct frequency drive motor. Adjustable drum
speed control and adjustable roast fan speed
control.

Roast drum:

Digital pressure control. Cast iron drum with
high performance bearings.

Heating system:

Gas burner by propane gas (LPG, bottle gas)
or city gas.

Voltage:

1 phase 230V / 50-60 HZ

Painting:

Free choice and customized / RAL codes

Roast roof:

Free choice and customized

Dimensions:

Length 1328 mm x width 720 mm x height
1715 mm

Exhaust pipe:

Exhaust pipe diameter for roast air: Ø 150 mm

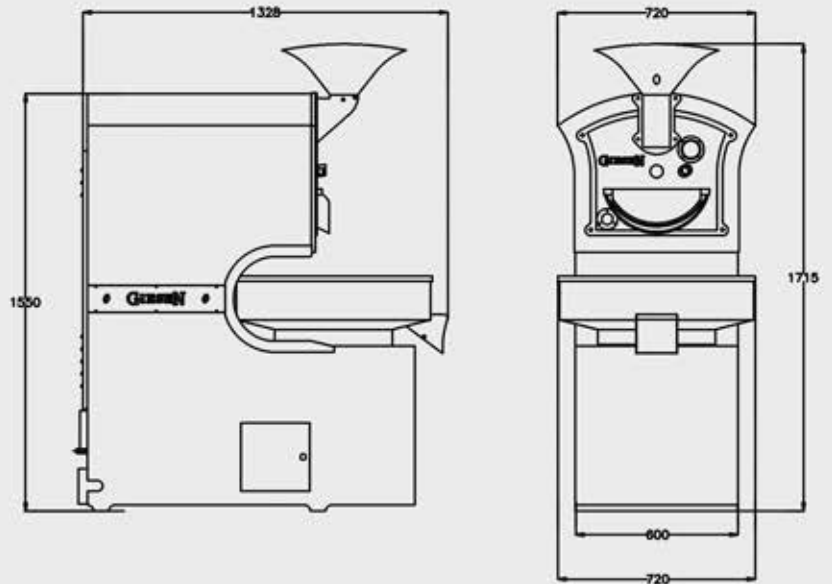

Visit us on our website:

www.giesencoffeeroasters.eu

or call us at: **+31(0)315 68 13 77**

GIESEN[®]
coffee-roasters